

# SCOOPY+



*Getting started*

Characteristics may change without any prior notice for improvement purpose

55 000 073-C © 2015

## Front panel and controls



1. Hang up key: Press the **Red phone** key to release a connection
2. **Mic button 3** : To enable/disable microphone input 3
3. **Esc / Power** key : Hold it for 3 seconds to start the ScoopFone **Power On/Off** and Esc key
4. OLED display
5. **OK / Menu** key : Menu access and validation
6. Joystick : Menu navigation & Validation
7. Call key: Use the **Green phone** key to initiate a call
8. Headphone 1: Handles the level with the center knob, handle the balance between send and receive signal with the external ring
9. Level control: This potentiometer controls microphone level 1
10. **Mic button 1** : To enable/disable microphone input 1
11. Alpha numeric keypad
12. **Mic button 2**: To enable/disable microphone input 2
13. Level control: This potentiometer controls microphone level 2
14. Headphone 2: Handles the level with the center knob, handle the balance between send and receive signal with the external ring
15. Function key F1: Marker or Relay
16. Audio player : Fast Review
17. Audio player : Play a recording
18. Audio player : Play and record stop
19. Record key : Start a new recording
20. Audio player : Fast Forward
21. Function key F2 : Marker or Relay

## Rear panel and Network interfaces

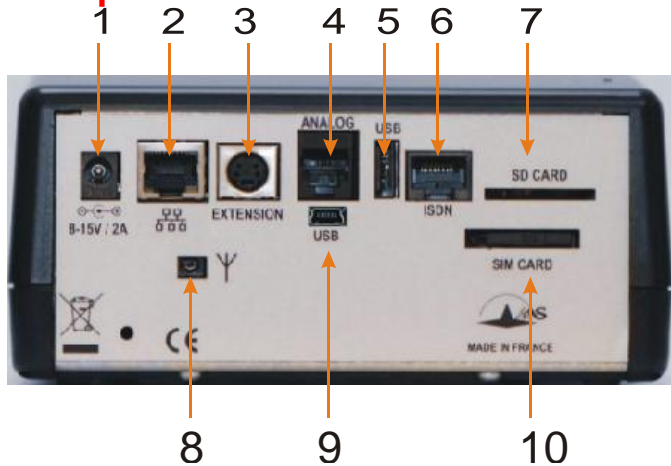

## Main and Menu display

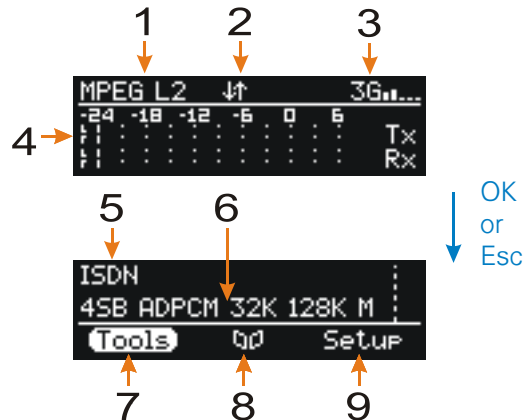

1. External DC Jack
2. Ethernet RJ45 Jack
3. Audio device extension connector, compatible with Mixy
4. POTS RJ11 Jack ( POTS Option)
5. USB interface to an external mobile module
6. ISDN RJ45 Jack ( ISDN Option)
7. SD card holder (Use by RECORDING Option)
8. External antenna connector for integrated mobile module
9. USB (Mini-B) : Sound card interface for PC or MAC
10. Removable drawer for SIM card ( Wireless Option )

1. Current Algorithm
2. Link : Mobile data connection enabled
3. Current Network for outgoing call, with mobile level reception
4. Audio bargraphs : Show send (Tx ) and receive (Rx) audio levels
5. Current Network
6. Current Algorithm
7. Tools menu access
8. Directories menu access
9. Setup menu access

# INTRODUCTION

We advise you to read this quick guide to start using the Scoopy+ in a very short time. For more detailed information on each step, do not hesitate to consult the full user manual on our web site:

[www.aeta-audio.com](http://www.aeta-audio.com)

In this guide, we assume most of the main basics are known and that you already have a microphone and a headphone connected.

## SETTING UP

### Powering

Before switching on the Scoopy+, you need to have 6 C/LR14 batteries inserted in the bottom compartment, and/or an external DC power connected on the DC jack.

### Battery

Scoopy+ works with non rechargeable or NiMH batteries.

Six 4500mAh NiMH batteries provide autonomy for more than 4 hours.



### External power supply

You can use an external power DC. Scoopy+ needs 12V DC but is able to work with a voltage from 8 to 15V / 2A minimum.

The external DC supply is also used to charge the batteries. Only NiMH batteries are supported by the internal charger.

### Antenna (Wireless option)

The Scoopy+ has an optimal internal antenna. In place of the internal antenna, Scoopy+ can use an external antenna connected on the rear panel [8].

### SIM card (Wireless option)

To establish a mobile communication, you should have a SIM card from a telecom operator. Scoopy+ supports a standard size SIM; use a card adaptor to support a micro SIM Card (Contact your dealer for more details).



Switch OFF the unit to insert the SIM card in the unit.

Remove the drawer [7] by pushing its small button, insert the SIM card inside and put it in place.

Info: For a new SIM card, use a mobile phone to activate your prepaid SIM card; to avoid undesired tones, disable waiting call tone.

## SET A CALL

The Scoopy+ should have been configured before this step. If it isn't the case, go to network configuration chapter:

- Ethernet, page 7
- ISDN, page 8
- POTS, page 8
- Mobile, page 8

### Switching Scoopy+ on/off

To switch Scoopy+ on, press  3 seconds.  
Press the same key 3 seconds to switch off.

### Step for wired network

Connect the Scoopy+ to the wall socket through the right network interface (page 3): Ethernet [2], POTS [4] or ISDN [6].

### Step for mobile network

Set up the unit by pressing  / [Setup / Network / Mobile Parameters / PIN](#). Enter the PIN code for the SIM card using the keypad if necessary.

## Adjust your microphone(s) level

Turn ON the mute LED indicator with the mute key, i.e.



for microphone 1

Set the Level control ([9] for mic. 1) on middle position, white dot of the button in topmost position.

Make a test with your microphone.

If the level is too high or too low on the display, adjust the gain through the menu [Setup / Audio / inputs / Input x Settings / Gain](#) until you get the right level.

### Set a call

Enter directly from the main screen the number or address of the destination, using the digital keypad.





Press the 0 key twice to have the international + symbol.

Press # to switch the keyboard mode between abc, ABC, 123 (Choice indicated on top right of the display).

Push joystick to the [LEFT](#) to erase the last digit.

Press the  key to launch the call.



## Set a call with a memory

Press the  key and select the directory menu , select [Remote Prof.](#) Move to your profile with the joystick and press  key to launch the call.

## Hang up

Press twice  to hang up.

## Redial

Press the  key to access the call history list. Select the number and press  again.

## GENERAL SETUP

Follow next steps to change the current configuration.

### To set the LANGUAGE

Enter the menu by pressing . Use the joystick to select [Tools](#), [Misc](#) to access to the [language](#) option.

### To select another NETWORK

Enter the menu by pressing , then [Setup / Network](#). Select [Change Network](#), and then scroll down using the joystick to the suitable network.

### To select another coding ALGORITHM

Enter the menu by pressing , then [Setup / Algorithm](#). Here you can see a list of previously selected coding algorithms. Use “[Other](#)” to create a new coding configuration, or select a previous one using the joystick.

Press the  key to activate it.

### To select AUDIO parameters

Enter the menu by pressing , then [Setup](#). Scroll down the list till you have [Audio](#). You will have another list with all parameters, including the [Inputs](#) and [Outputs / Headphones](#) configuration. Please consult the complete user manual for detailed information.

Info: you can return to the previous step at any time by pressing .

## How to reset your unit

In case of trouble, you can reset your current configuration through menu [Tools / Misc / General Reset / Reset settings](#) or [Factory Reset](#). With factory reset, all configurations will be deleted.



INFO: Your Scoopy+ can receive any incoming call as soon as it is powered on. Scoopy+ will switch automatically to the suitable network on an incoming call.

## ETHERNET IP NETWORK

Connect your SCOOPY+ to the Ethernet network via the Ethernet port.

Set up the unit in IP mode over Ethernet: enter in the menu [Setup / Network / Change Network / Ethernet](#).

You can check if the Ethernet connection is active if you can see a light on the RJ 45 connector and if the IP address is clearly identified. To find the IP address of your unit on the network, enter the menu [/ Tools / About / Local IP](#).

## Change audio quality

To select the coding algorithms: enter in the menu [Setup / Algorithm / Other](#) then choose your algorithm according to the network quality and rate.

Note: In case you want to use a SIP proxy server, please consult the complete and detailed user manual for SCOOPY+ as you will have to enter other mandatory information (in the AOIP parameters menu!).



**IMPORTANT**

On the public IP network, or if you don't use a SIP server, we highly recommend to use a STUN server.

Enter the menu by pressing , then [Setup / Network / AoIP Parameters / STUN Server](#).

Enter an IP address, for example  
[stun.aeta-audio.com](http://stun.aeta-audio.com)

by using the front panel keyboard, then press .

Come back to [STUN Mode](#) in the menu and select [On](#).

## ISDN NETWORK

Connect your unit on the ISDN network, set your unit to ISDN through [Setup / Network / Change Network / ISDN](#).

To choose the protocol depending of local country, please enter the menu [ISDN Parameters / Protocol](#).

To select the coding algorithms: enter in the menu [Setup / Algorithm / Other](#) then choose your algorithm according to the network quality and rate.

## POTS NETWORK

Connect your unit to the network via the RJ11 connector. To set up your unit in POTS mode: [Setup / Network / Change Network / POTS](#).

When this is done you can select "encoded" (CELP) mode or [Hybrid](#) mode. The encoded mode is compatible only with AETA POTS codec. The Hybrid mode is compatible with standard phones.

Adjust the needed parameters (Line level, DTMF, etc.): see the detailed user manual).

## MOBILE NETWORK

Note: A SIM Card should have been inserted in the drawer located on the rear panel of Scoopy+

Set up the unit by pressing  / [Setup / Network / Mobile Parameters / PIN](#). Enter the PIN code for the SIM card using the keypad if necessary.

### **Data Mode (Broadcast quality)**



On the public IP network, or if you don't use a SIP server, we highly recommend to use a STUN server. See grey box on page 7.

In the menu [Mobile Parameters](#), select [Mode / IP Mode](#). Then come back to menu [Preferred Technologies / Auto](#).

Then in the menu select [Access Point / APN](#): enter the APN code for your operator using the keypad,

press 



To select the coding algorithms: enter in the menu [Setup / Algorithm / Other](#) then choose your algorithm according to the network quality and rate.

### **Cellphone mode (internal mobile only)**

Set up the unit by pressing [/ Setup / Network / Mobile Parameters / PIN](#). If necessary, enter the PIN code for the SIM card using the keypad.

In the menu [Mobile Parameters](#), select [Mode / Cellphone](#).

Come back on [Preferred Technologies](#) to set it to [Auto](#).

The menu [Network Operator](#) enables you to choose among the available network operators if this is allowed with your mobile subscription.

### **To get HD Voice over mobile (7 KHz bandwidth)**

To get a HD Voice connection, some conditions are required:

- Both devices in the connection must support HD voice
- Support of HD voice by your mobile operator's network
- Very often, only the 3G network supports HD voice. This depends on the country or area, and the operator.

For this last reason, having a connection on 3G can be a condition to get HD Voice. In this case, the 3G is a useful indication that HD Voice is possible.

In addition, it is possible to force the operation on 3G mode: [/ Setup / Network / Mobile Parameters / Preferred Technologies / Only 3G](#).

### **INMARSAT BGAN NETWORK (Option)**

See the user manual.

## COORDINATION CHANNEL



- This feature is available only with internal wireless option.
- You don't need to set the Mobile Service to the cell phone mode for having a coordination line.
- The coordination line is available at all time, except if you have established a stereo connection.
- The coordination channel can't be used if you already have a cell phone connection as main channel.

Set up the unit by pressing / [Setup / Network / Mobile Parameters / PIN](#). Enter the PIN code for the SIM card using the keypad if necessary.

### Set the audio interface for coordination

The coordination channel can be enabled through [Setup / Audio / Routing for mono](#). You can choose between two modes: [PGM& Coordination](#) (default) and [PGM & Coordination \(auto\)](#). In automatic mode, the coordination line is monitored only when a connection is established.

You can specify which microphone is used for the coordination channel through the menu [Setup / Audio / Inputs / Input x Settings / Audio routing](#) with [coordination](#) option.

Also, you enable the coordination return on each headphone by menu [Setup / Audio / Outputs Headphones / Headphone x](#).



### Set a call

To set a call, select / [Menu / Setup / Coordination](#), enter the phone number to call and press 

## RECORDING (optional)



Recordings are saved on the SD Card mounted in the rear panel holster [7].

### Recording



Press twice  to start a new recording. To pause the recording, simply press the  key. By pressing it again, the recording resumes.



Recording stops by pressing the  button. A new recording file is added to the list with a new index.

### Play back

Press  key, select a file with the joystick. Press  again to listen to it or  to access a popup menu. You can play it back also during a live transmission.

## Make a take (Extract a part of a recording)

During playback, press  to mark the beginning and press  to mark the end cue. Press  to save your selection into a new **Take**.

You can transform your **Take** into a recording file. From the menu  / **Takes**, select the take,  and select **Export** from the popup menu.

## Send a file to the studio

Enter in the menu, select  and **Records**. Make  on the file and select **Send** from the popup menu to transfer it through an IP connection (Mobile or Ethernet).

Note for mobile transfers:

If it isn't the case, set Mobile Service to **IP mode** and activate the data connection through menu **/ Setup / Network / Mobile parameters / data active**. On the display, an icon shows the data connection (See page 2, [2]).

Note: The FTP server should be configured beforehand in the menu **/Tools / Misc / FTP Parameters**



## CONTACTS / RELAYS

You can transmit 2 “contact” states along with the audio program during an established link. These contacts can e.g. control relays or lamps on the remote side.

Conversely, 2 “relay” states can be received from the remote side.

Note: to be effective, this feature should be enabled on both sides. Some algorithms don't support it with ISDN.

Enter the menu by pressing , set [Tools / Misc / Aux. Functions / Relays](#) to ON.

During the connection, with  and  you can toggle the contact states sent to the remote side. A pop-up window shows their resulting state. You can recall it from the main window by pushing the joystick to the right.

The Info 1 and 2 LEDs show you the state of the received “relay” states.

*These states can actually close relay contacts if you use the relay extension accessory.*

# WEB INTERFACE

Once the SCOOPY+ is connected on an IP network, the first step is to get its IP address, from the menu: [Tools / About / Local IP](#). On the control computer, launch the html browser and enter the IP address of the SCOOPY+ in the "address" or "URL" field. This gives access to the html server integrated in SCOOPY+, offering the status and full management of the unit:

The screenshot displays the SCOOPY+ web interface. At the top left is the AETA Audio Systems logo. The main title 'SCOOPY+' is centered. A navigation bar includes tabs for STATUS, CONNECTIONS, PROFILES, NETWORK, AUDIO, RECORDS, CODING, MISC, MAINTENANCE, and ALARM (0). A 'Logout' link is in the top right. Below the navigation bar is a 'Refresh All' button. The interface is divided into several sections:

- GENERAL:** Battery Level: No Battery; Current Network: Ethernet; Coding: MPEG L2 48kHz 64kbit/s Mono; 5AS: On; Tests: None; SMS: On.
- ETHERNET:** Mode: DHCP; IP Address: 10.0.20.39; Subnet Mask: 255.255.255.0; Gateway: 10.0.20.254; DNS Server 1: 10.0.20.3; DNS Server 2: ; Link Mode: 100baseT-FD.
- AUX. FUNCTIONS:** Data Channel: Not available; Baud Rate: Not available; Relays: Off.
- ISDN:** Protocol: Euro ISDN; Codec Mode: Single Codec.
- MOBILE (INT.):** Mode: Cellphone; Network: Orange F; Mobile network type: HSPA; Signal strength: -101 dBm.
- POTS:** Dialing Mode: Tone; Country Code: France.
- CONNECTION STATE:** Status: Established; Network: Ethernet; 1. Remote Address: 10.0.20.90; Coding Algorithm (Tx): MPEG L2 48kHz 64kbit/s Mono; Coding Algorithm (Rx): MPEG L2 48kHz 64kbit/s Mono.
- Headroom:** A bar chart showing Tx and Rx levels. Tx is at approximately -10 dB and Rx is at approximately -5 dB. The scale ranges from -24 dB to 6 dB. Headroom is 12 dB.

At the bottom, the footer contains: AETA AUDIO SYSTEMS - VISIT [WWW.AETA-AUDIO.COM](http://WWW.AETA-AUDIO.COM) and VERSION: 3.0-ALPHA - SW BUILD: 2013-02-28.

## NOTE

## ACCESSORIES



Carrying bag



Car adapter cable



Spare AC/DC adapter



External multiband antenna



Audio extension: MIXY



Relay extension

# AUDIO SYNOPTIC

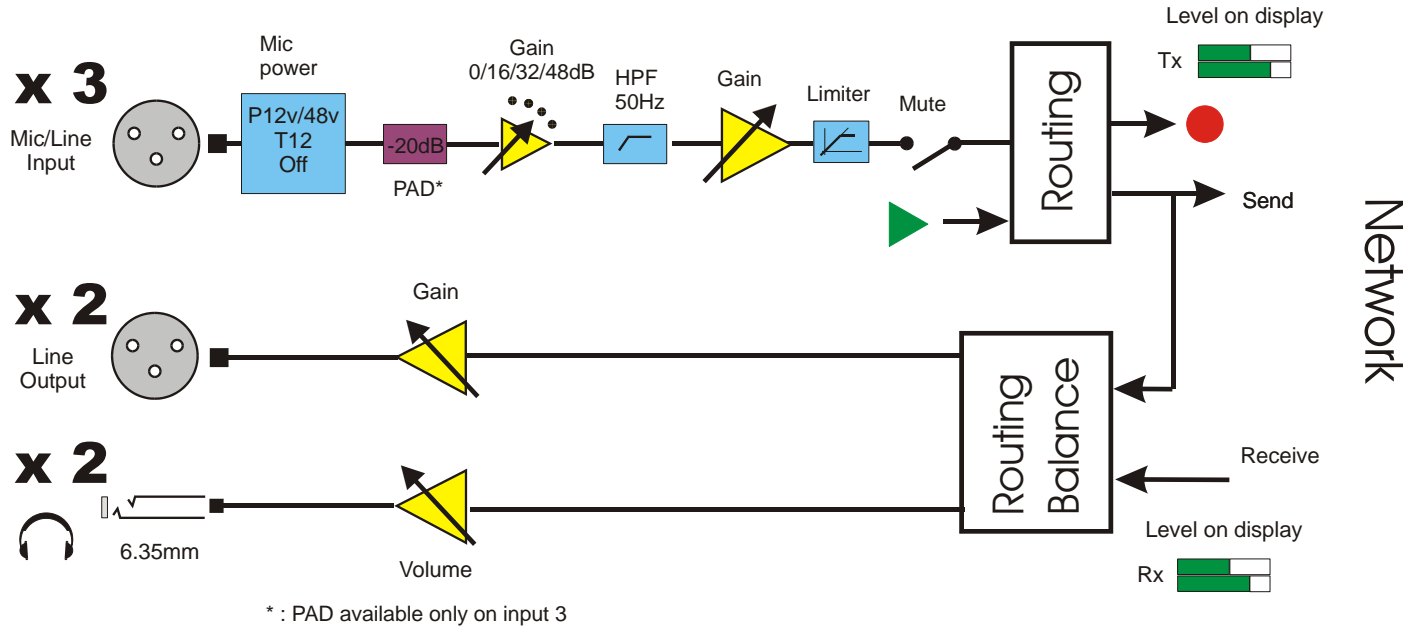



## HOT LINES FOR AETA CODEC TESTS

ISDN: +33 1 41 36 12 68  
 POTS: +33 1 41 36 12 75  
 IP: 200@86.64.17.66

## APN Codes (mandatory for wireless IP data)

---



---



---

## Your own numbers

---



---



---



---



---



[www.aeta-audio.com](http://www.aeta-audio.com)

## AETA AUDIO SYSTEMS S.A.S.

IMMEUBLE KEPLER 4 - PARC TECHNOLOGIQUE  
 18/22 AV. EDOUARD HERRIOT  
 92350 LE PLESSIS-ROBINSON - FRANCE

**TEL. : + 33 141 361 200**  
**FAX : + 33 141 361 269**